

# AIPHONE



## GT SERIES

Hands-Free Color Video Apartment System with Picture Recording, Zoom & PanTilt Features





For  
Apartment  
Buildings

# Sophisticated Design

The GT Series provides an innovative wide angle camera view to provide better security to residents.



With its wide angle view, GT Series catches a visitor in a wheel chair, or someone who tries to hide from the camera.



# and Reliable Security

Residents can record their visitors anytime they want, even during their absence. This recording function gives them greater peace of mind.



Records 6 shots per picture sequence.

If a call is received from the Entrance Station, the Residential Station automatically starts recording, or residents start recording anytime by pressing the REC button manually.



# Residential Station



## Wide and Zoom & PanTilt

GT-2C-L, GT-2C  
GT-1C-L, GT-1C

### ■ Panoramic Wide Angle View

To provide effective security, GT Series features a wide angle camera that enables you to see an innovative panoramic view! People standing on sides and people of all heights can be easily identified.

### ■ Zoom

To see details, switch to Zoom mode. Switching between Wide and Zoom mode can be done by the press of a button.

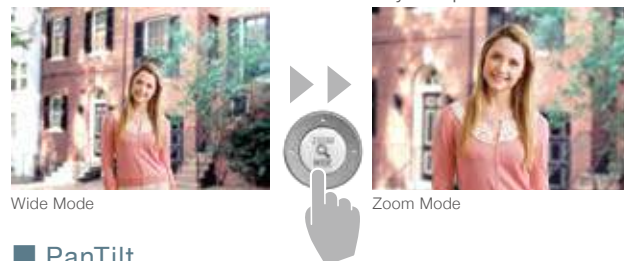

### ■ PanTilt

PanTilt is available to change the camera angle in Zoom mode.

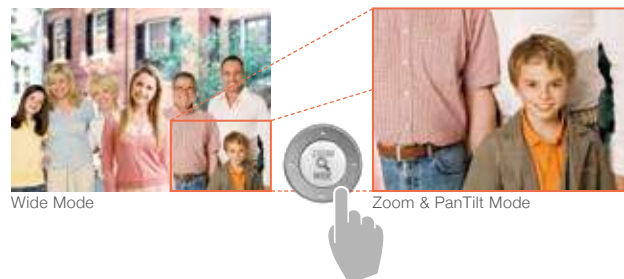

## Supports Hearing Aid with T-mode **GT-2C-L, GT-1C-L, GT-1M-L**

A T-coil mode is now available with the GT Series. If your hearing aid features T-mode, the sound from the GT Residential Station is much clearer than other intercoms.

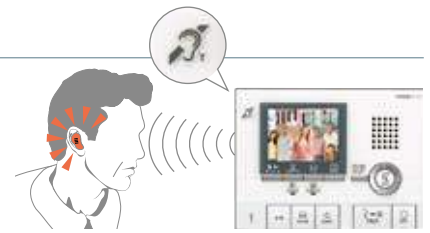

## Picture Memory **GT-2C-L, GT-2C**

### ■ Automatic Recording

Works anytime, even during your absence. Records 6 images per picture sequence. Up to 40 pictures sequences can be recorded.

### ■ Manual Recording

Record picture as required. The recording starts when you press the REC button while monitoring or talking to a visitor.

### ■ Playing

The play LED flashes when there are auto-recorded pictures. Press the PLAY button to play.



## Additional Security **GT-2C-L, GT-2C**

The Master Station with the recording function can be connected with 3 security lines and an emergency button. If a connected sensor detects a break-in, or an emergency button is pressed, the alarm will be triggered after the set time. (An emergency button can be connected to any Master Station.)

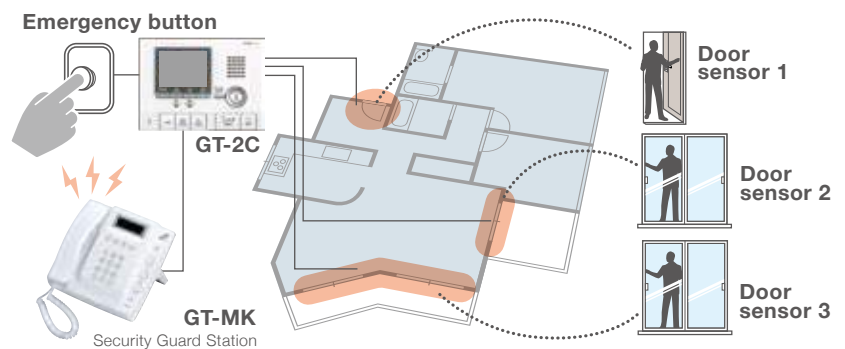

## Find a Matching Style

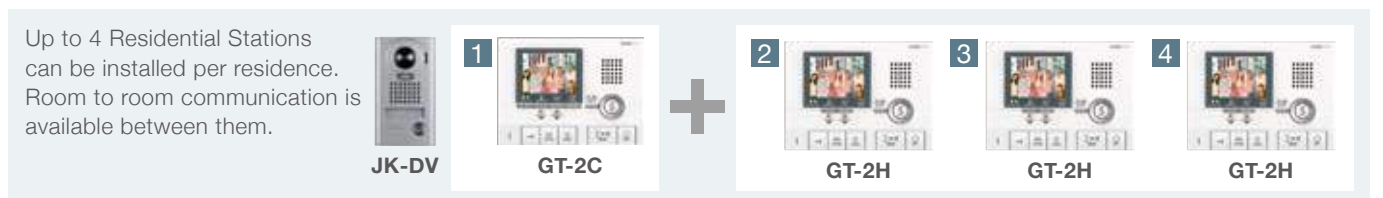

## Door Station

You can now identify visitors not only at the apartment entrance, but also at your door. The Door Station sends a clear color image just like the Entrance Station.



## Main Features of the Camera

- Fish eye wide lens camera.
- Automatic LED illuminator for low light conditions.
- Both with/without camera types are available.

# Entrance Station



## Audio & Visual Guidance

The Entrance Station features both audio and visual guidance, so any visitor knows the present situation. The audio guide is available in 6 languages (English, French, German, Spanish, Dutch, and Italian).

There are projections on the buttons to help visually impaired visitors.



GT-DA-L



GT-DM



Call in progress.

Please speak now.

Door open.

## 2 Styles to Choose From

Select from the All-in-one type or Module type. The All-in-one comes with the large display, digital name scrolling feature, and sophisticated design. The Module has a direct-select call feature, and can be flexibly combined with the direct button panels.



All-in-one type



Module type

## Optional Security Camera for More Security

To eliminate blind spot and ensure entrance security, you can add the optional security camera.

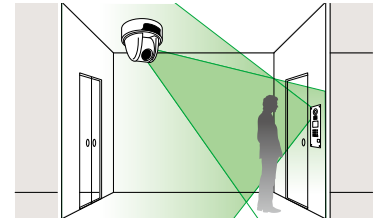

## Panoramic View Angle & Clear Color Image

With the white LED illuminator, the camera sends color images to Residential Station monitors at any time. Clear color image is always available! With its advanced camera, you can identify visitors and monitor the entrance in innovative panoramic view.



## Convenient Resident Search

With the Digital Name Scrolling station, visitors can find the residents easily by their names or room number using the digital keypad. Directory search is also available.

\* With alpha and numeric characters, room numbers can be entered (max. 6 characters).  
Scandinavian added for showing resident names (max. 32 characters).



## Other Features

- Up to 500 four-digit access codes can be set.
- Both with/without camera types are available.

# Security Guard Station



## Reception Mode

Using this function, all Entrance Station calls are automatically transferred to the Security Guard Station, giving the security guard the ability to screen visitors.

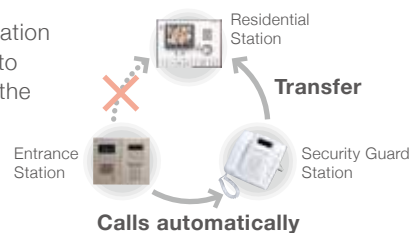

## Missed Calls Recording

Records up to 20 missed calls made from Residential Stations. To call back, display the resident's name and room number recorded, and then press the Call button. It's quick and easy.



## Other Features

- Receives panic call from Residential Stations.
- Optional doorbell at security/reception room is available.
- Supports hearing aid with T-mode.
- Both wall and desk-top installations are available.



GT-MK



GT-MK  
with desk-top stand

## Installer-Friendly Terminal Block

The terminal block can be removed from the station unit. It makes the installation easier and protects the station against theft during the installation.



## Installation Advantage

### Installation and Setup is Quick and Easy

- Employs 1 pair for audio & 1 pair for video connections
- Easy link to Residential Station from Entrance and Security Guard Stations
- Programmed data can be transferred to other GT-DM, GT-NS and GT-MK's
- For GT-DM, GT-NS and GT-MK, system setup data is programmable on your PC. GT-DM, GT-NS, and GT-MK & PC can be connected with a USB connection cable. Setup tool software is supported in 6 different languages (English, French, German, Spanish, Italian and Dutch).

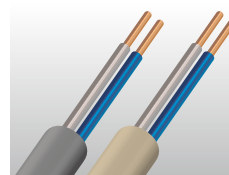

1 pair for audio & 1 pair for video



Programmable on your PC

The system setting tool is compliant with Windows XP, Windows VISTA and Windows 7.

## Expanded System Advantage

### Operates Up to 16 Entrance Stations, 4 Security Guard Stations, and 500 Residential Stations: Ideal for Large Apartment Complexes!

The GT series can accommodate large complexes with underground parking, complex building layouts, and many residents. It provides two Communication (talk and video) paths\*, one per Common-Sub trunk. Choose the installation configuration that best suits your application. The design flexibility and capacity of the GT makes it suitable for all multi-unit applications, large and small.

\* Communication paths are subject to installation requirements. See page 8 for more details.

### Two communication paths available





## System Configuration

### Standard system

5 Entrance stations  
2 Security guard stations  
48 Residential stations

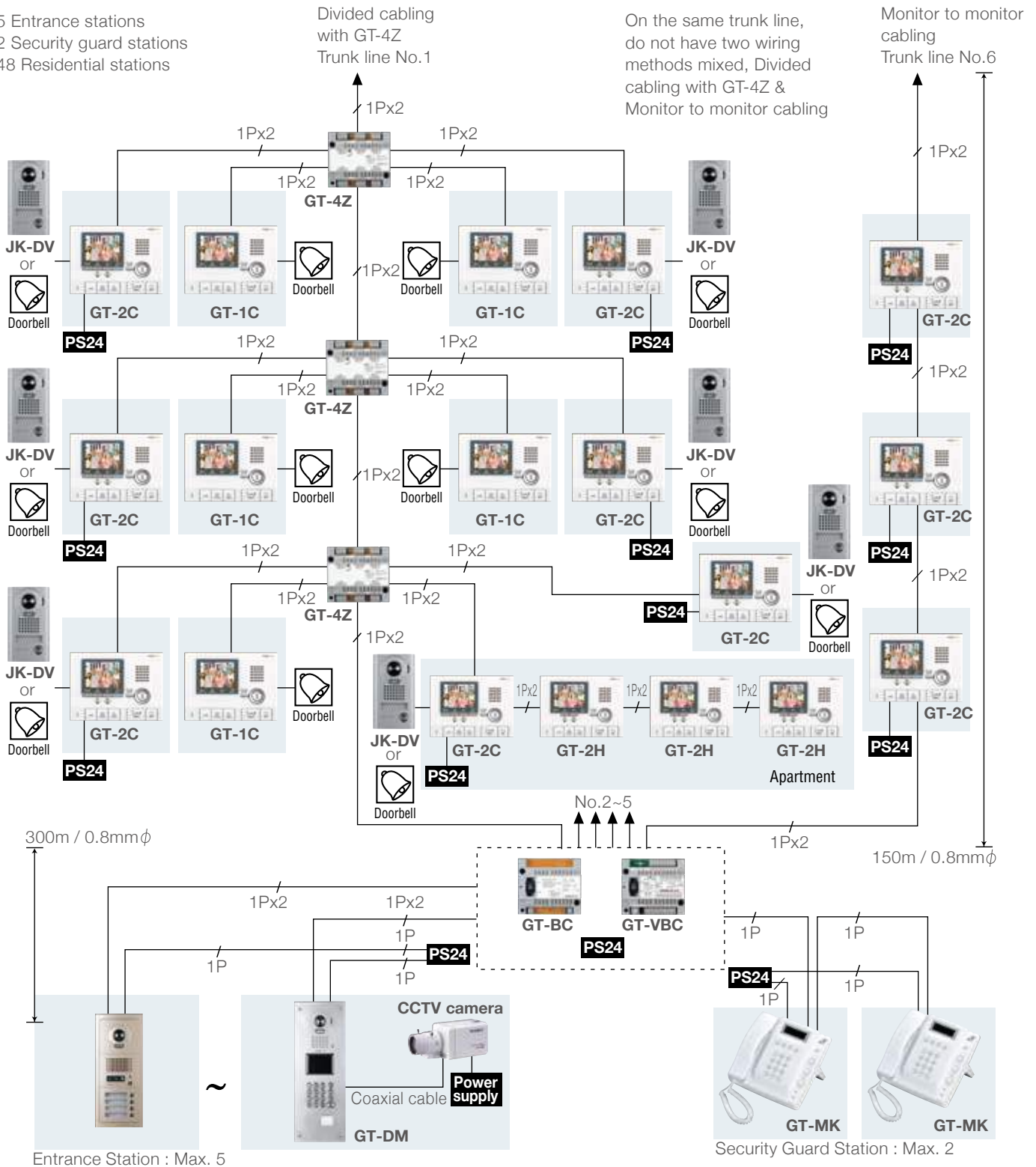

Wiring distance:  
Entrance station - Bus & Video control unit 300m  
Video control unit - Farthest Video Apartment station 150m  
(Expandable with additional Video control unit)  
Bus control unit - Farthest Audio Apartment station 300m  
Accumulated total Audio wiring distance 2,500m



# Expanded system

16 Entrance stations, 2 common trunk lines (8 each per common line)  
 4 Security guard stations, 2 common trunk lines (2 each per common line)  
 500 Residential stations, 4 sub trunk lines (125 each per sub trunk line)

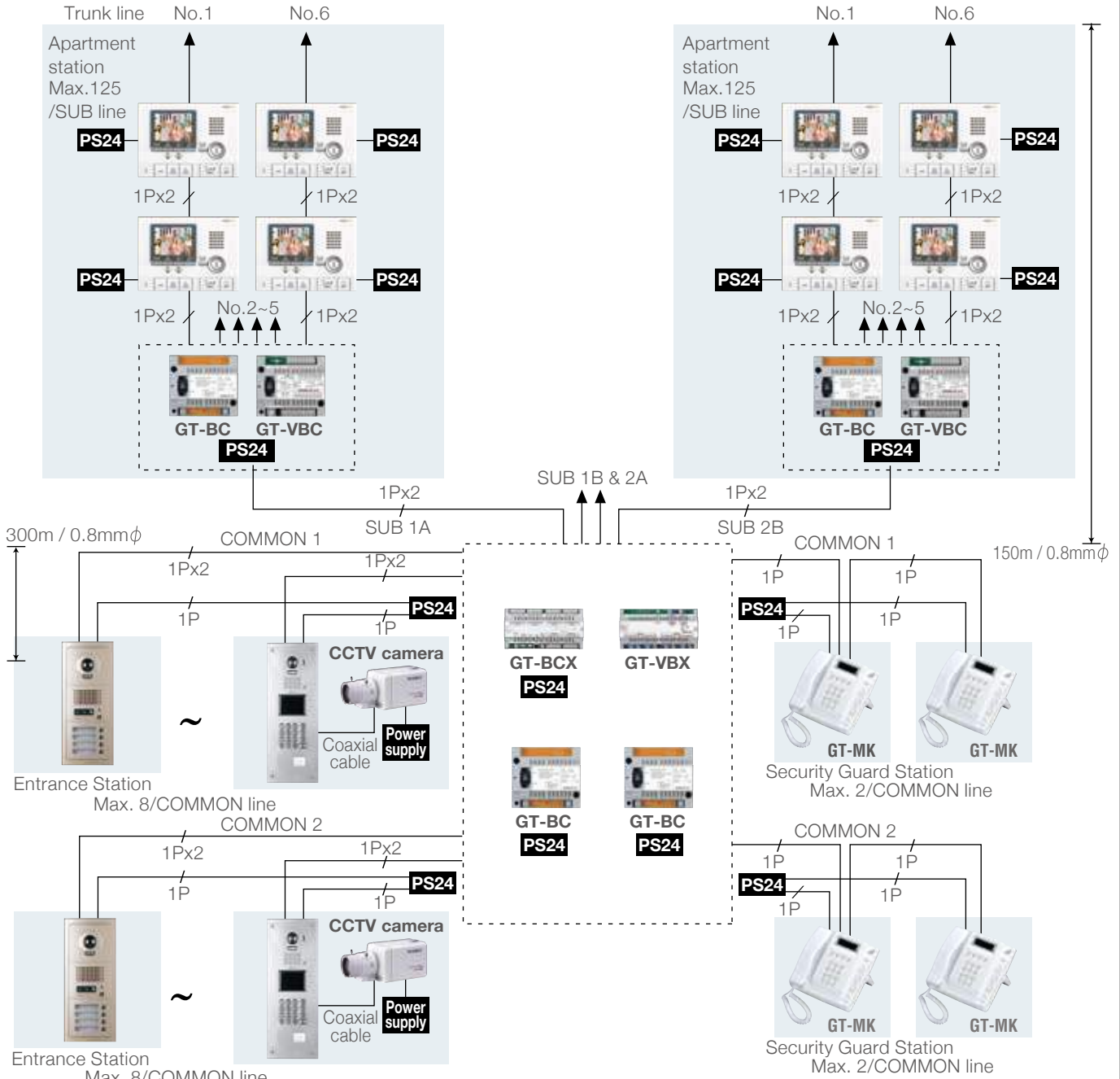

Wiring distance:  
 Entrance station - Expanded Bus & Expanded Video control unit 300m  
 Expanded Video control unit - Video Bus control unit 150m  
 Expanded Bus control unit - Bus control unit 300m  
 Accumulated total Audio wiring distance 2,500m/  
 SUB line

## Communication (talk and video) paths:

Communication paths on GT-BCX and GT-VBX are identified as "COMMON 1" and "COMMON 2". Each related COMMON-SUB trunk has its own communication path that can be used within itself for communication between Entrance and Resident. Crossover to the other trunk is possible, but this will occupy both talk and video paths. Also Security Guard communication occupies an entire system.

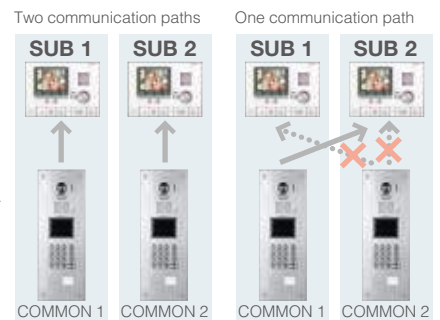

## Entrance station

### All-in-one type Digital name scrolling

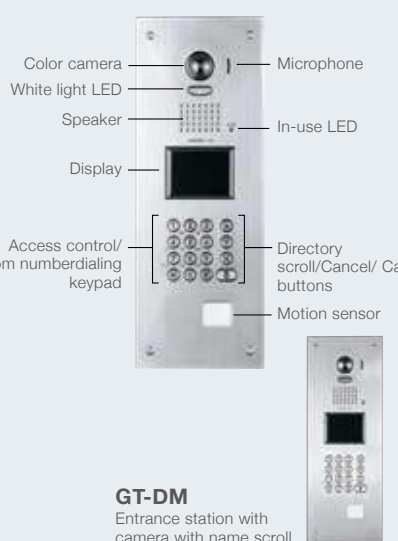

**GT-DM**  
Entrance station with camera with name scroll

### Module type Direct-select call button



The directory button panels back-lit display illuminates resident's name or unit number

### Digital name scrolling





---

### Audio Module

  
**GT-DP**  
Audio panel for GT-DA

  
**GT-DP-L**  
Audio panel for GT-DA-L

  
**GT-DA**  
Audio module

  
**GT-DA-L**  
Audio module w / guide display

### Camera Module

  
**GT-VP**  
Camera panel

  
**GT-VA**  
Camera module

### Access control keypad module

  
**GT-AC**  
Access control keypad module

---

### Option

  
**GF-AP**  
Address panel

  
**GT-AD**  
Address module

  
**GF-BP**  
Blank panel

### Digital name scrolling module

  
**GT-NSP-L**  
Display module panel

  
**GT-NS**  
Digital name scroll display module

### Front frame & back box

  
**GF-10KP**  
10-key module panel

  
**GT-AD**  
10-key module

---

### Call switch Module

  
**GF-1P**  
1-call panel

  
**GF-2P**  
2-call panel

  
**GF-3P**  
3-call panel

  
**GF-4P**  
4-call panel

  
**GT-SW**  
Call switch module

  
**GT-4F**  
4-module front frame

  
**GT-4B**  
4-module back box

  
**GF-3F**  
3-module front frame

  
**GF-3B**  
3-module back box

  
**GF-2F**  
2-module front frame





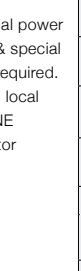

  
**GF-2B**  
2-module back box

  
**GT-nH**  
Rain hood

  
**GT-nHB**  
Hooded surface-mount box

  
**GF-nBA**  
Surface-mount box

## Entrance station components

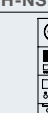
Number of calling button		4.	8.	12.	16.	20.	24.	25.-48.	GH-NS, GF-10K
									
(1)	GT-VA GT-VP	1 1	1 1	1 1	1 1	1 1	1 1	For more than 7 X GH-SW, additional power supply & special device required. Contact local AIPHONE distributor	1 1
(2)	GT-DP(-L) GT-DA(-L)	1 1	1 1	1 1	1 1	1 1	1 1		1 1
(3)	GT-SW GF-4P	1 1	2 2	3 3	4 4	5 5	6 6		— —
(4)	GF-3F GF-3B	1 1	— —	2 2	2 2	— —	3 3		— —
(5)	GT-4F GT-4B	— —	1 1	— —	— —	2 2	— —		1 1
(6)	GF-BP	—	—	—	—	—	1		—
	GT-AD GF-AP	— —	— —	1	—	1	—		—
(7)	GT-NS GT-NSP-L	— —	— —	— —	— —	— —	— —		1 1
	GT-10K GF-10KP	— —	— —	— —	— —	— —	— —		1 1
									1

## Residential station

 Hearing aid



**GT-2C-L**  
Monitor apartment master station w/ picture memory



**GT-2C**  
Monitor apartment master station w/ picture memory

 Hearing aid



**GT-2H-L**  
Monitor apartment sub master station



**GT-2H**  
Monitor apartment sub master station

 Hearing aid



**GT-1C-L**  
Monitor apartment station



**GT-1C**  
Monitor apartment station

 Hearing aid



**GT-1M-L**  
Monitor apartment station



**GT-1A**  
Audio apartment station

 Hearing aid



**GT-1D**  
Audio apartment station

**GT-HS**  
Optional Handset



## Video door station



**JK-DA**  
Wide and Zoom & PanTilt video door station, surface mount



**JK-DV**  
Wide and Zoom & PanTilt Vandal-resistant video door station, surface mount



**JK-DVF**  
Wide and Zoom & PanTilt Vandal-resistant video door station, flush mount

## Door station



**GT-D**  
Audio only door station

## Residential station

 Hearing aid



**GT-MK**  
Security guard station



**GFW-S**  
Desk-top stand

## Control units



**GT-BC**  
Bus control unit



**GT-VBC**  
Video Bus control unit, expander video control



**GT-4Z**  
Video 4-zone divider

## Expanded control units



**GT-BCX**  
Expanded Bus control unit



**GT-VBX**  
Expanded video control unit



**PS-2420**  
(without AC cord)  
**PS-2420S**  
**PS-2420UL**

## Option



**GT-RY**  
External signaling relay entrance light, external buzzer



**W-DIN11**  
DIN mounting rail for GT-BC, GT-VBC, GT-4Z



**AC-10S**  
Access control keypad, surface mount



**AC-10F**  
Access control keypad, flush mount



**GTW-LC**  
Lift control adaptor



**AE7090220B**  
**AE7090220G**  
**AE7090210B**  
**AE7090210G**  
AIPHONE approved product wire

10



## ■ COMPARISON BETWEEN GT SYSTEM AND GH SYSTEM

	GT system	GH system
Total Residential stations	Standard:48 stations (picture memory type: 48 masters and 144 subs) Expanded: 500 stations (picture memory type: 500 masters and 1500 subs)	Standard:48 stations Expanded: 500 stations
Number of Residential Stations within a Residence	Up to 4 stations (up to 2 monitors) (picture memory type: up to 4 monitors)	Up to 4 stations (up to 2 monitors)
Zoom & Pan tilt	Available	Not available
Picture memory	Available (picture memory station only)	Not available
Camera angle preset	Available	Not available
Audio guidance on entrance station	Available (GT-DM and GT-DA-L only)	Not available
Video door station at residence	Available (picture memory station only)	Not available
Call tone selection	Available (picture memory station only)	Not available
Switches between entrance station and CCTV camera	Available	Not available
Security sensor connection	Available (picture memory station only)	Not available
Number of access codes on entrance station	Up to 500	Up to 20
Code length of access code on entrance station	4, 5, or 6 digits	4 digits
T-coils for hearing aid	Available	Not available
PC connection at programming	USB	RS232C

\*GT series cannot be combined with GF or GH Series.

## ■ UNIT DIMENSIONS

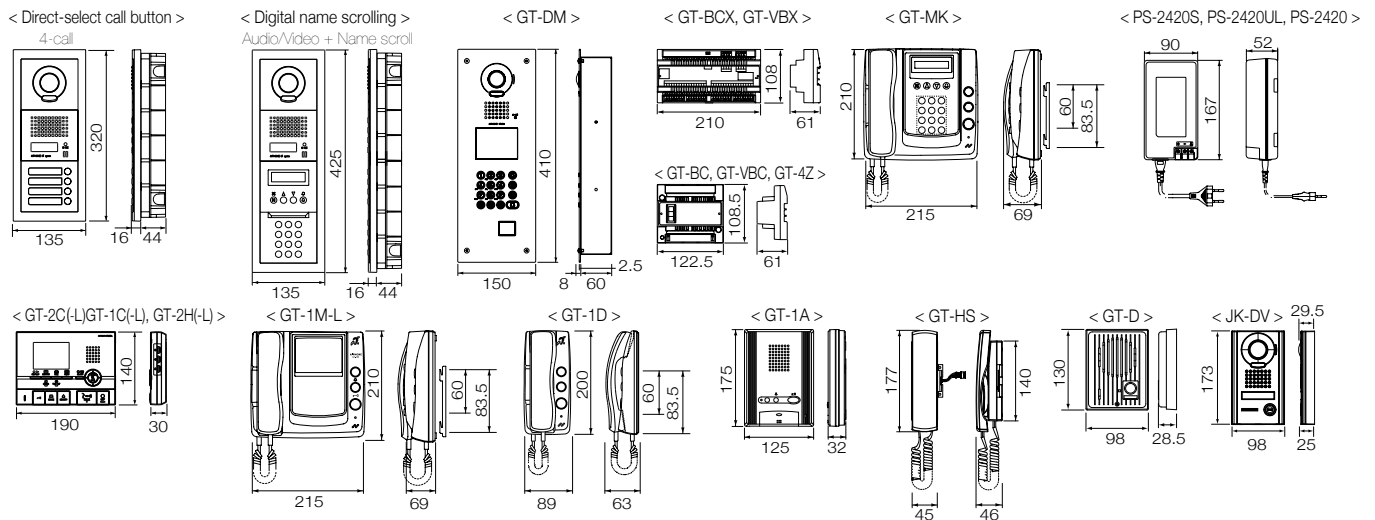

## ■ FEATURES OF RESIDENTIAL STATION

Model name	Description	Picture memory	Zoom & Pantilt	T-coils mode	Communication	GT-HS	Service button	Residential door station	Residential door bell	Security sensor
GT-2C	Video apartment master station	✓	✓	—	Hands-free	✓	✓	✓	✓	✓
GT-2C-L	Video apartment master station	✓	✓	✓	Hands-free	✓	✓	✓	✓	✓
GT-1C	Video apartment station	—	✓	—	Hands-free	✓	✓	—	✓	—
GT-1C-L	Video apartment station	—	✓	✓	Hands-free	✓	✓	—	✓	—
GT-2H	Video apartment sub master station	—	✓	—	Hands-free	✓	✓	✓*	✓*	✓*
GT-2H-L	Video apartment sub master station	—	✓	✓	Hands-free	✓	✓	✓*	✓*	✓*
GT-1M-L	Video apartment station	—	—	✓	Handset	—	✓	—	✓	—
GT-1A	Audio apartment station	—	—	—	Hands-free	—	✓	—	✓	—
GT-1D	Audio apartment station	—	—	✓	Handset	—	✓	—	✓	—

\* Function of GT-2C and GT-2C-L

## ■ CAMERA POSITION & IMAGE VIEW AREA

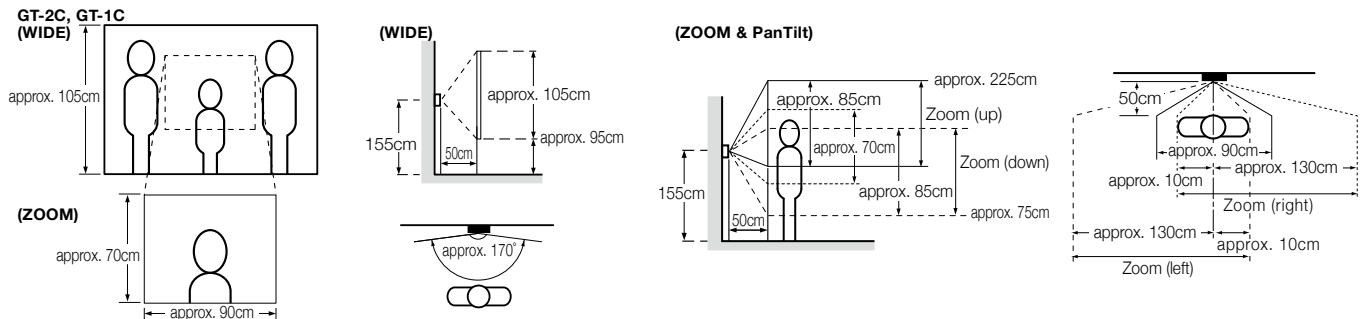

The image on the monitor is simulated to explain the functions. It is different from the actual image.

Distributed by :



Deming Medal



ISO 9001 Certified  
JQA-0291  
AIPHONE CO., LTD.



ISO 14001 Certified  
JQA-EM0453  
Headquarters section  
Toyota Factory  
Taiho Site  
AIPHONE CO., LTD.

**AIPHONE®**  
Providing Peace of Mind

<http://www.aiphone.net/>

Printed in Japan  
QB53025A0Z

GT(E)1103A

All rights reserved. All statements valid at time of printing. The design and specifications are subject to change without notice for improvement.